

QUICK HITCH VALVE

59 Kremzow Rd, Brendale, QLD, Australia 4500
 Tel: +61 7 3881 3312, Fax: +61 7 3881 3314
 Email: sales@hyteco.com.au
 Web: www.hyteco.com.au

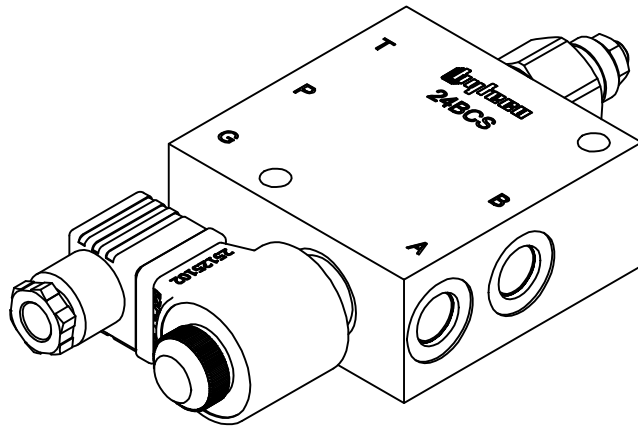

Max pressure: 315 bar, Reducing 10-210 bar
 Capacity: 30 L/min.
 Ports: P,T,A,B : #6 SAE (9/16" UNO)
 G : G 1/4"-19 BSPP
 Mounting: 8.5mm THROUGH

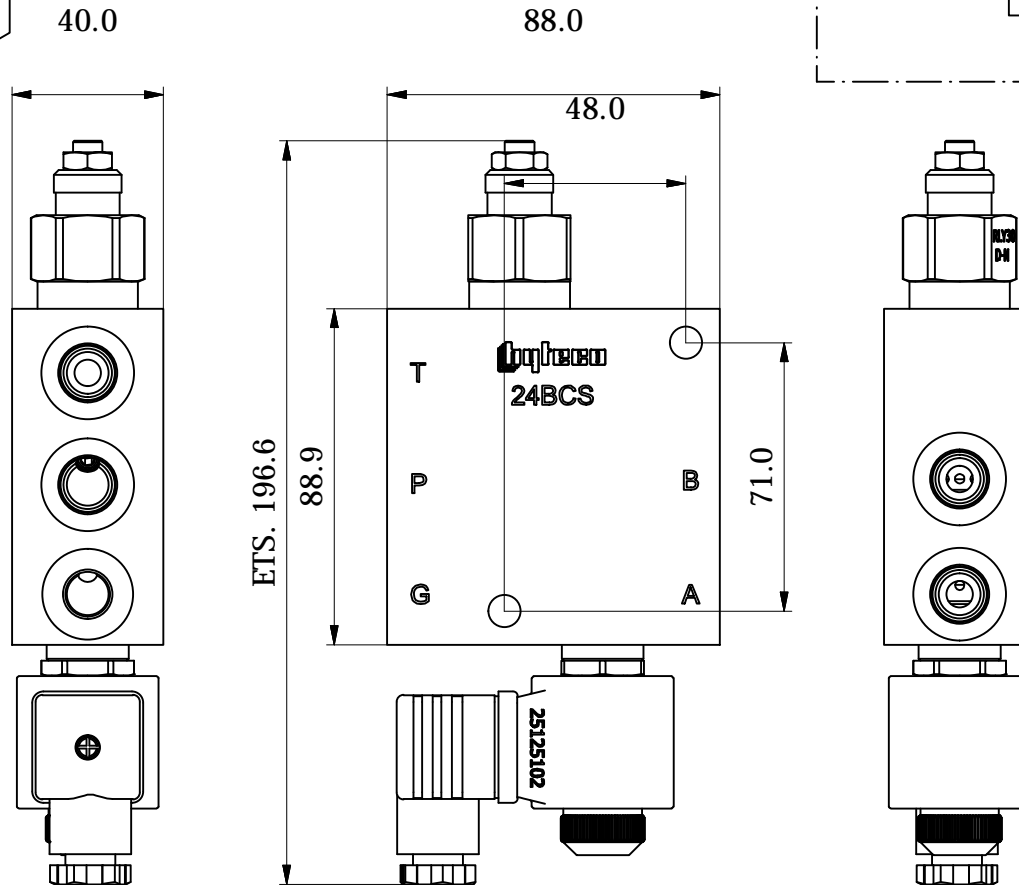
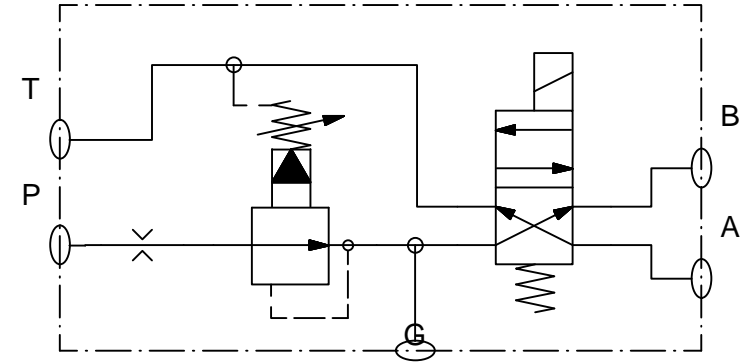

Ordering Code	Approx. Weight (kg)
ETD24BCS-10B	2.368 kg

Voltage Series
 Voltage: A: 12VDC
 B: 24VDC